

Mérések az 5G NSA és lehetőségek az 5G SA hálózaton

Magyar Telekom

M2M and Campus Development Squad

Soós Gábor

2022. november

5G - MORE THAN A NEXT STEP

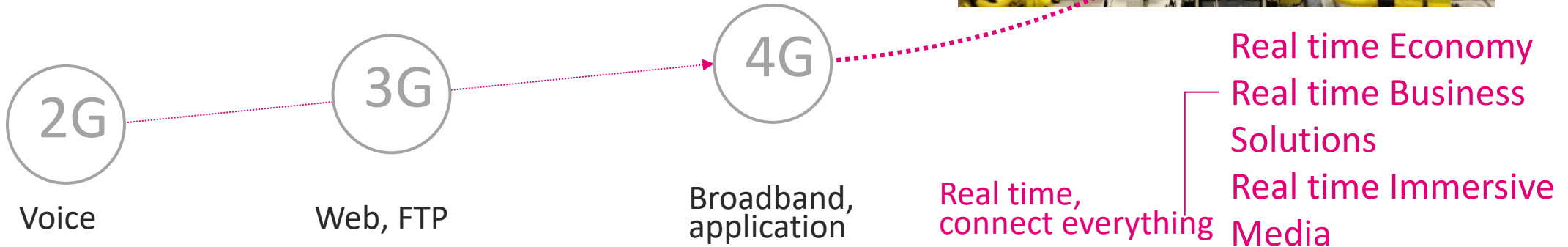
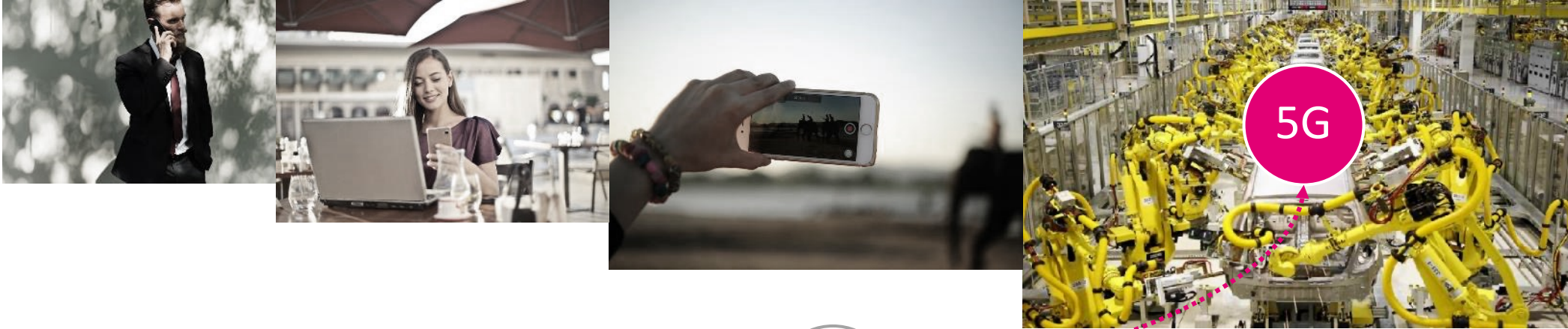

5G-NSA Temporary, Reliable, wire-free connectivity for festival payments – crowded area

- **Wireless** connection for payment terminals
- **<10Mbps DL/UL** agg. throughput demand
- **Reliable, guaranteed** service
- **At various locations**
- **Covering large areas**

- Not only for festival payments
- Numerous other segments are interested too!



Successful live operation at 3 major festivals in 2022



- ~110 000 visitors
- 50 private network SIM cards connecting 150 payment terminals

- 450 000 visitors
- 150 private network SIM cards connecting 500-600 payment terminals

- 80 000 visitors
- 100 private network SIM cards connecting 200 payment terminals

Connectivity was uninterrupted and sufficient network speed was maintained for payment terminals at each event, despite public subscribers generated 10 000 times more network traffic

Network Statistics – example

NUMBERS NOT SHOWN
for confidentiality
reasons

Downlink throughput at busiest night

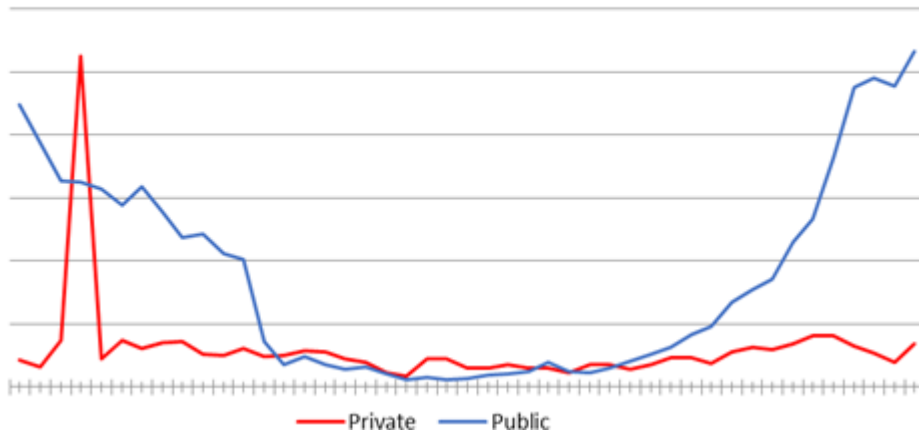

- Huge load on public slice
- No effect on private slice

NUMBERS NOT SHOWN
for confidentiality
reasons

Uplink throughput at busiest night

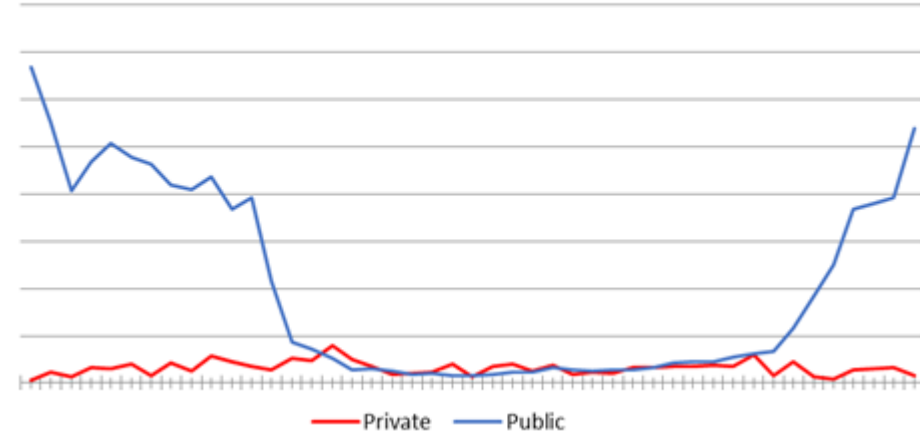

- Both uplink and downlink capacity guaranteed
- **Virtually 2 independent networks**

APZ – High-Speed measurements

motivation

- There are many high-speed V2X use-case
- Limited number of publications
- Limited number of vendor and MNO experiences

Requirements

- KPI targets for high-speed (+200 km/h):
- One-way latency under 20 ms
- Uplink throughput ~80 Mbps
- Handover without packet loss
- Fast handover without significant degradation



APZ – High-Speed measurements

5G Network specification

- Public, but empty 5G network
- 100MHz BW
- Multiple cells (Inter-Cell Handover)
- Changing line of sight
- Application server on Budapest (~200 km)
- 2 ms additional RTT latency

scope

- Intra-Cell Handover
- Changing line of sight
- Measurement traffic: 100 Hz, 100B ICMP packets
- Investigating RTT, Jitter, packet loss, Throughput
- Multiple measurement at 50, 90, 140, 170, 210km/h

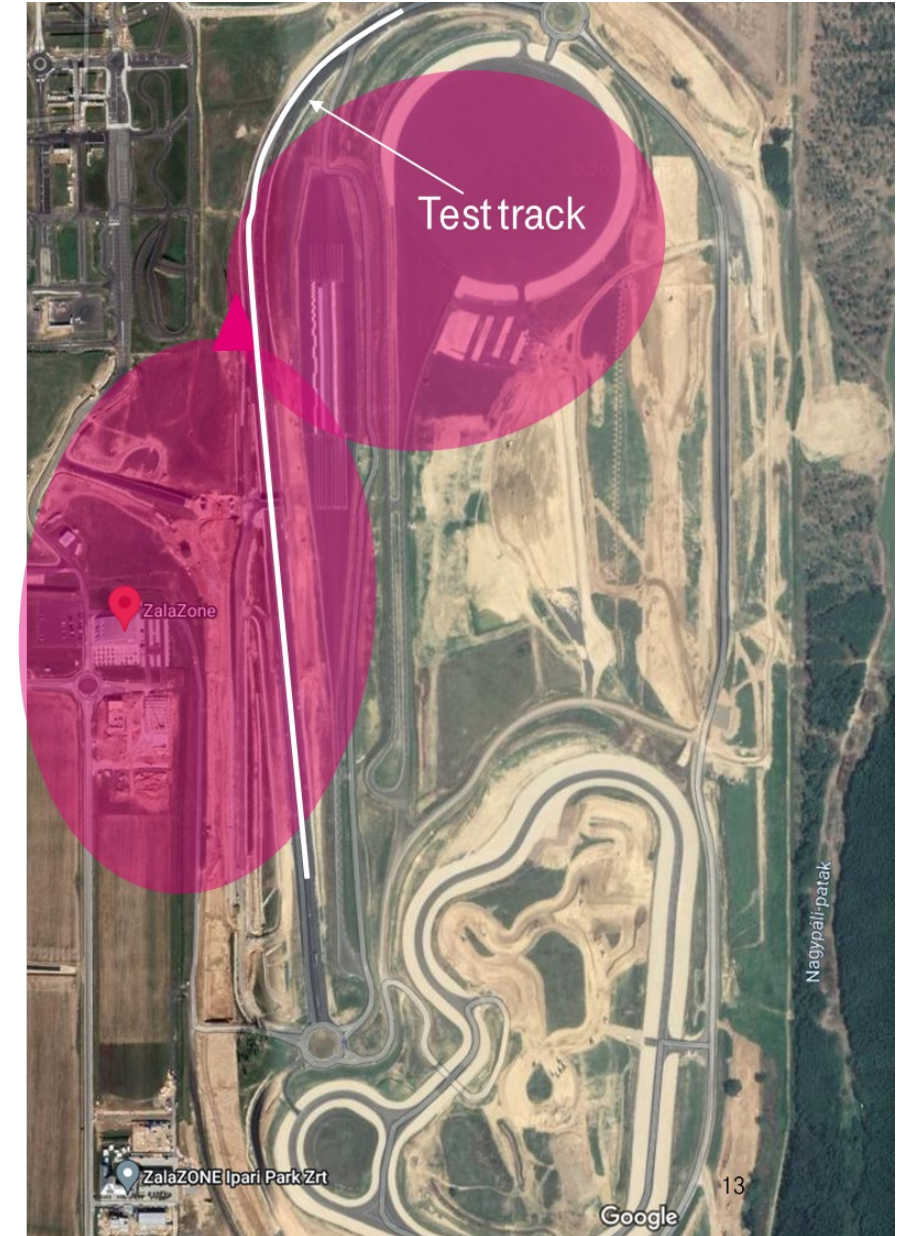

Tuned to High-Speed requirements

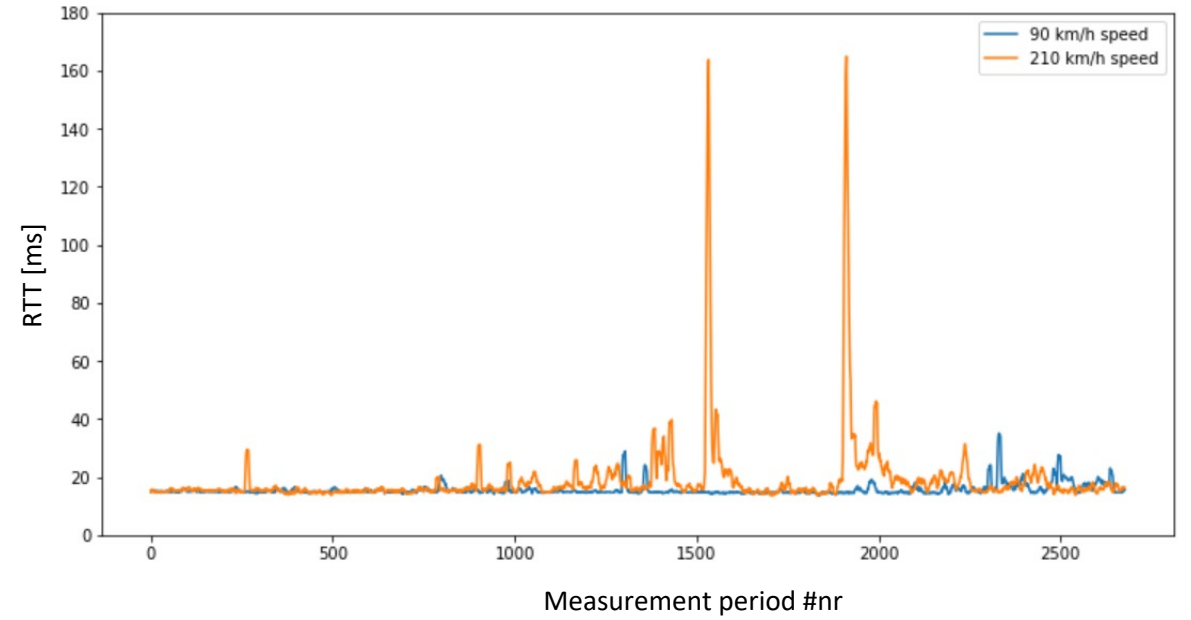
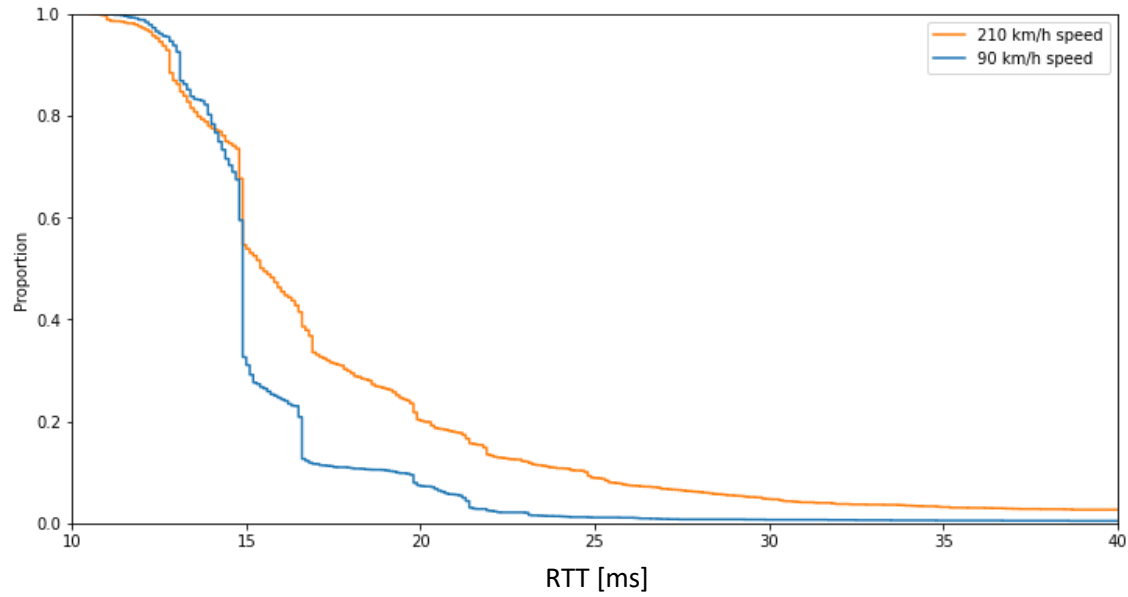

5G NSA - SOLUTION TWO NETWORK LAYERS – PARTED BY DIFFERENT NETWORK IDS

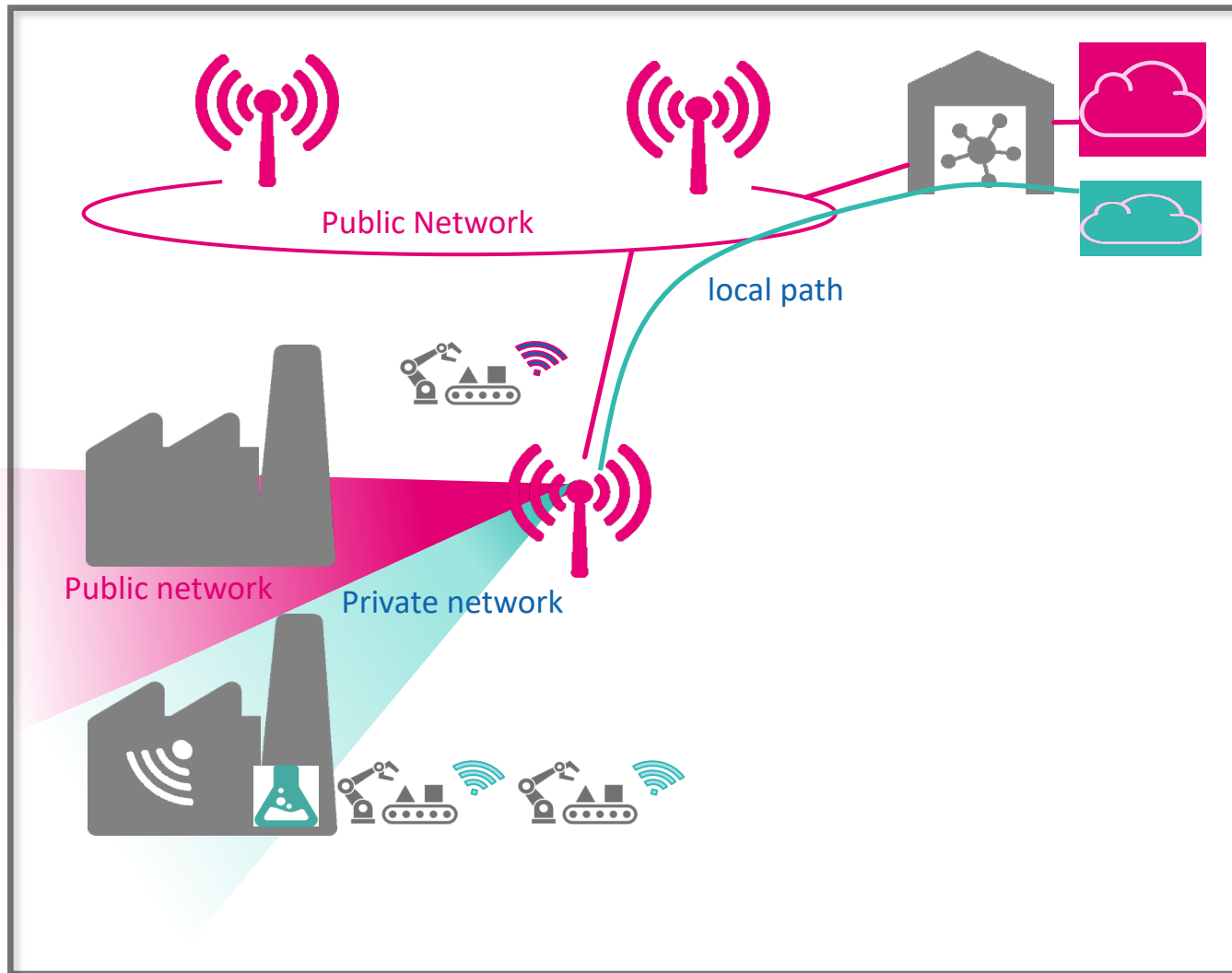

- Public network for human subscribers
- Private network for human/M2M communications
- Dedicated RAN (Radio Access Network) resource for the Private
- Shared radio layer with guaranteed resources and dedicated network ID (PLMN ID)
- Private/shared Core Network to keep traffic local and achieve high customer autonomy in combination with edge cloud on campus
- Network-as-a-Service offering matches the customer demand and understanding of a private network

5G-NSA static architecture

- Private (Campus) model – centralized core in MT data center
- Dedicated core resources, shared radio resources on one frequency layer
- Guaranteed uplink and downlink **capacity** for both networks, in core, IP and RAN segment
- Network configuration is static
- **Limited to few network slices (999-xyz)**

Not bandwidth!

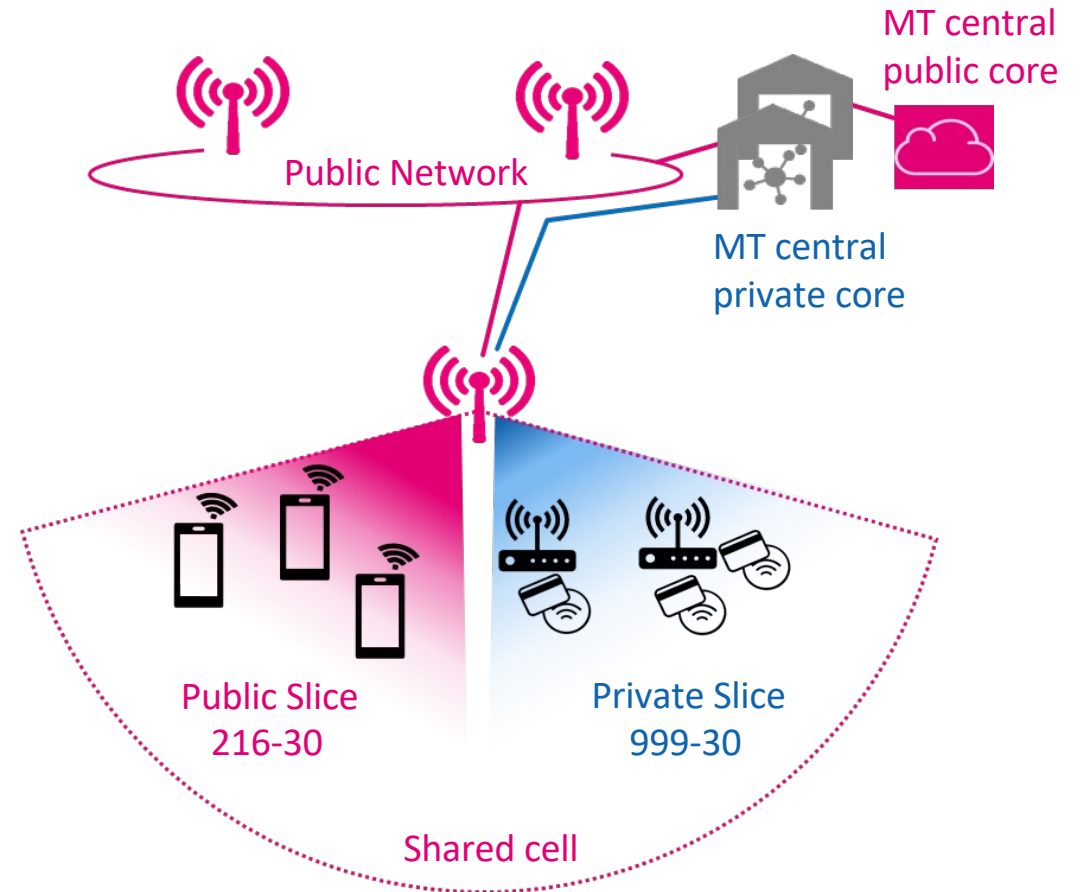

Dynamic Radio Resource Partitioning concept

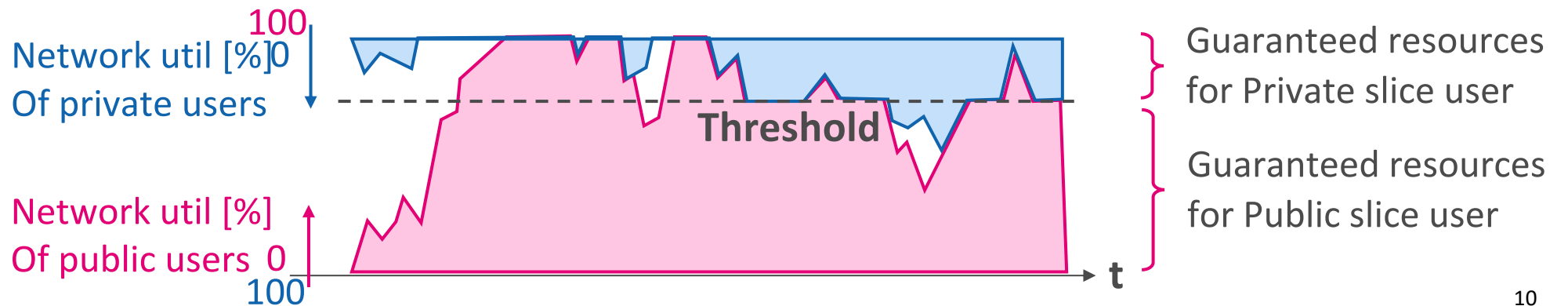

5G-SA business needs

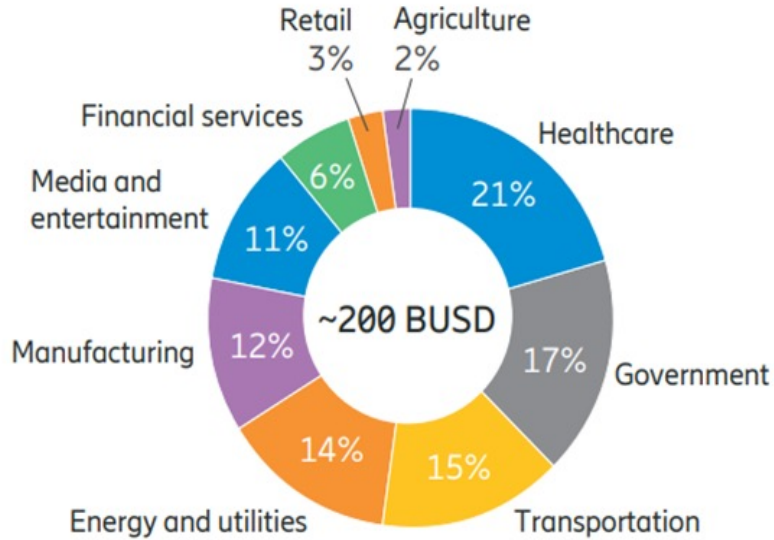

90%
of industry value in top 6 industries

23%-46%
CAGR in each industry (2025-2030)

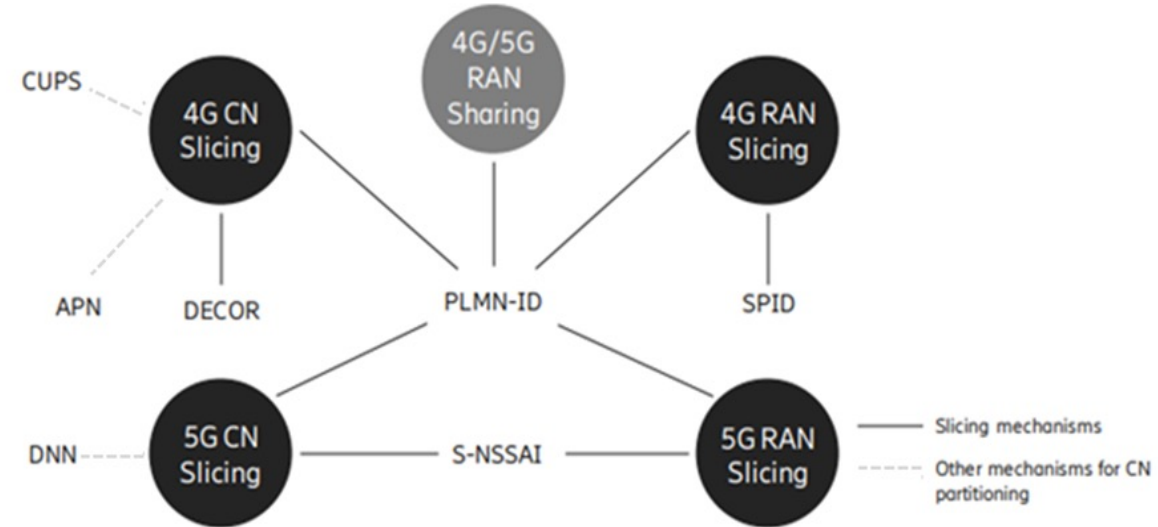

„The industries with the highest revenue potential for network slicing for CSPs (Network slicing: A go-to-market guide to capture the high revenue potential)” Ericsson 2022

5G – SA Slicing concept will open Many opportunities

Currently static PLMNID-Core mapping with 4G-EPC is in use.

5G-NSA Architecture support **maximum 2-3 classes, with same QoS level!**

With 5G-SA dynamic slicing, **many new services** can be introduced

New Network Slicing QoS Classes will allow new opportunities

- mapping of services of subscriber/groups
- allow/ban resources for different services/areas
- change dynamically the resource by customer services

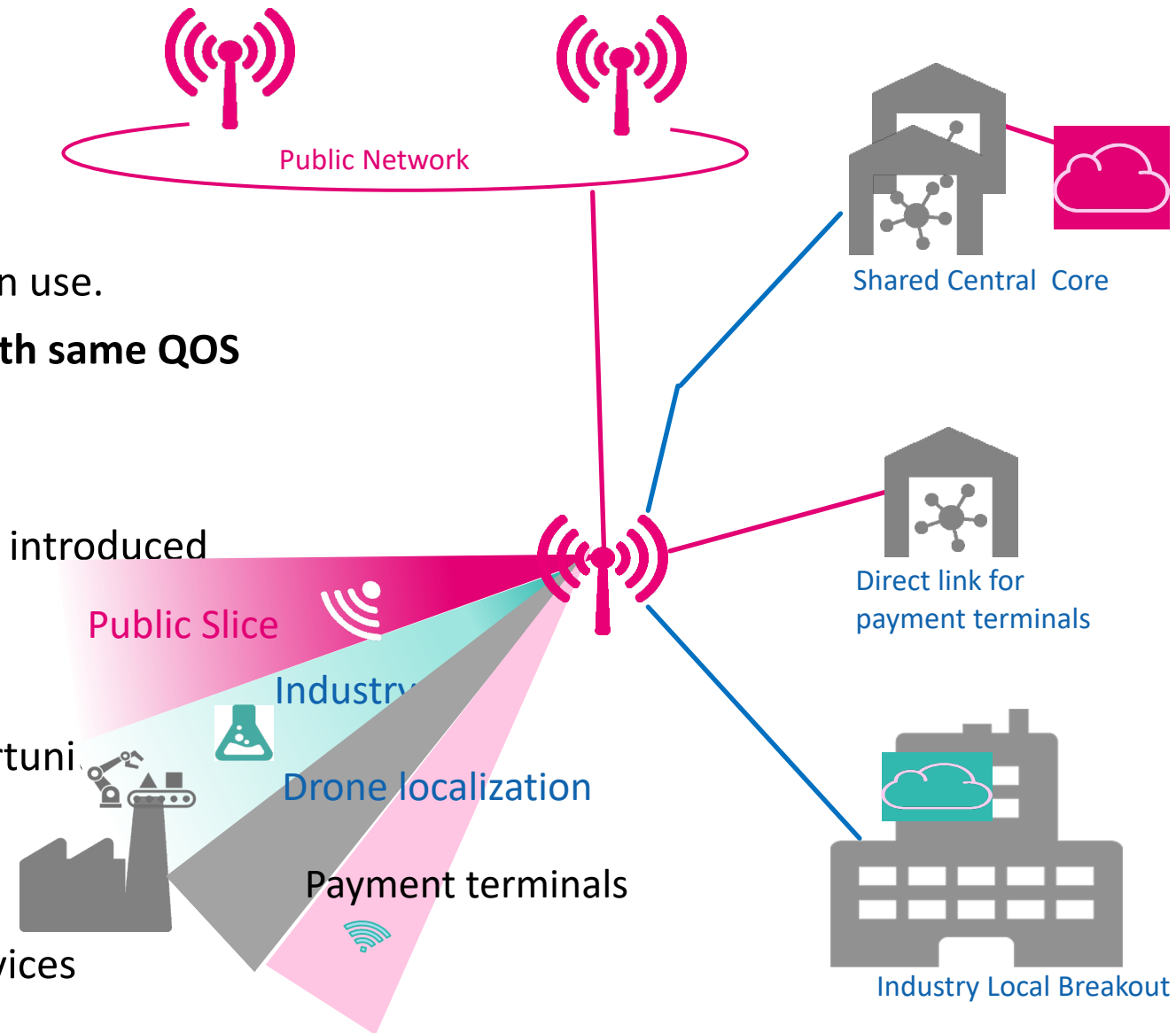

5G-SA Slicing architecture

- Dynamic configuration change
- **256+ network slice, based on APN, SIM, destination,**
- On-demand slicing and resources for subscribers
- Activated by e2e Orchestrator

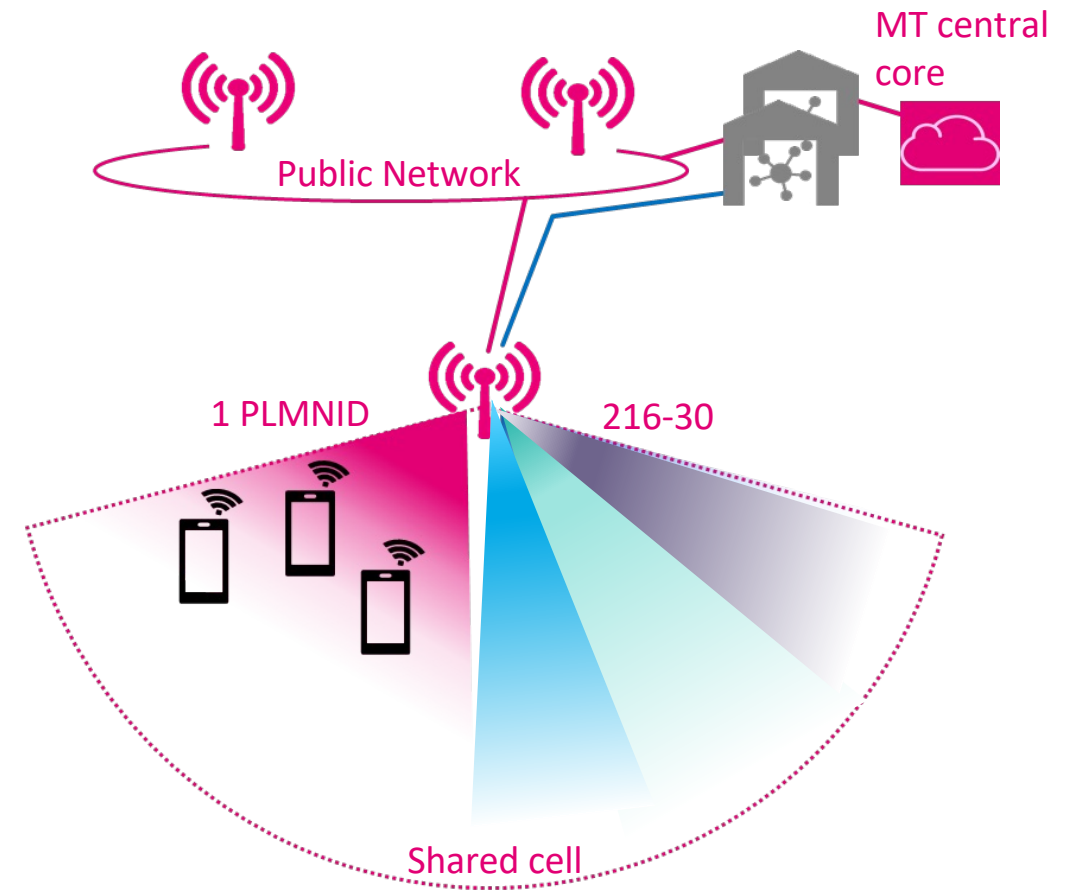

Dynamic Radio Resource Partitioning concept

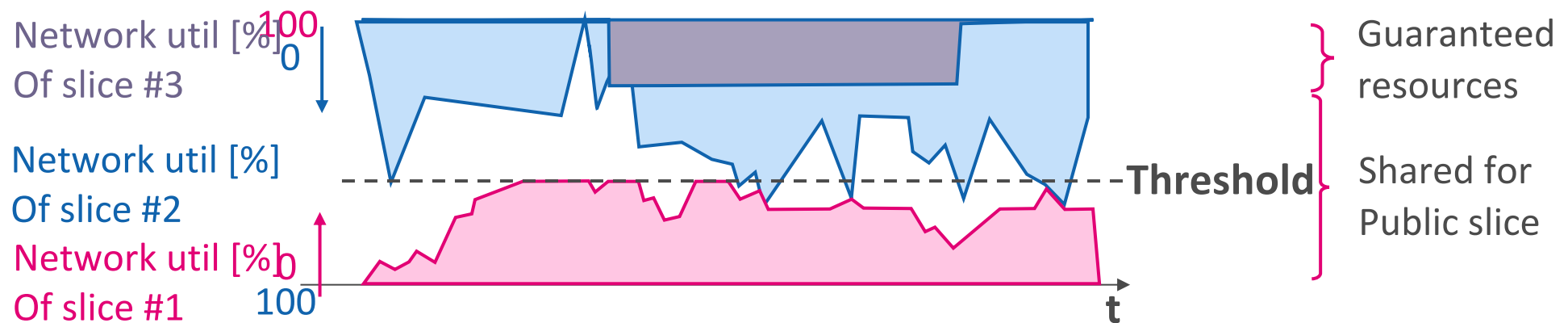

Q&A